

Soldering Hints

- Put leads through mounting holes from the side with part of the lead on the component evenly touch PCB.
- Solder leads at the other side. Solder should fully fill and cover soldering pads. Avoid bridges between neighboring pads.
- Cut unused leads flush with cutter.

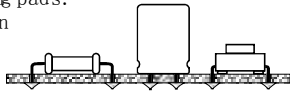

DSO 138 Oscilloscope DIY Kit User Manual

Rev. 01

Tools you need

- Iron (20W)
- Solder wire
- Multimeter
- Screw driver
- Flush cutter
- Tweezers

Before you start

- Check part values & quantities against part list
- Always meter resistor values before soldering
- Understand all part polarities and orientations

Step 1

Assembly Main Board and LCD board (follow the order as numbered)

1. Resistors



Note:
Always meter resistor values before soldering

- | | |
|--|---|
| <input type="checkbox"/> R1, R14, R16 : 100K | <input type="checkbox"/> R7, R36 : 180 |
| <input type="checkbox"/> R2 : 1.8M | <input type="checkbox"/> R8, R12, R13 : 120 |
| <input type="checkbox"/> R3 : 200K | <input type="checkbox"/> R9, R15, R26 : 1K |
| <input type="checkbox"/> R4 : 2M | <input type="checkbox"/> R10 : 3K |
| <input type="checkbox"/> R5 : 20K | <input type="checkbox"/> R11, R38 : 150 |
| <input type="checkbox"/> R6 : 300 | <input type="checkbox"/> R28, R40 : 470 |
| | <input type="checkbox"/> R37, R39 : 10K |

2. HF Chokes



- L1, L3, L4 : 100! H

3. Diodes



- Cathode
- D1 : 1N5819
- D2 : 1N4004 (or 1N4007)

4. Crystal



- Y1 : 8M Hz

5. USB Socket *



- J4 : USB mini-B

6. Tact Switches



- SW 4, SW 5, SW 6, SW 7, SW 8 : 6 X 6 X 5mm

7. Ceramic Capacitors



- C1, C9, C10, C11, C14, C15, C16, C17, C18, C20, C23 : 0.1! F
- C2 : 330pF
- C3 : 3pF
- C5 : 1pF
- C7, C8 : 120pF
- C12, C13 : 22pF

8. LED



Solder positive pole (the longer lead) to the square pad



- D3 : 3mm, green

9. Pin header (for power)



Face the opening outward

- J9 : 2 Pin

10. Transistors



- Q1 : 8550
- Q2 : 9014

11. Regulators



- U4 : 79L05
- U5 : 78L05

12. Capacitor trimmers



- C4, C6 : 5-30pF

13. Power inductor



- L2 : 1mH / 0.5A

14. Electrolytic capacitors



Solder positive pole (the longer lead) to the square pad



- C19, C21, C22, C24, C25, C26 : 100! F / 16V

15. Power connector



- J10 : DC 005

16. Pin-header (male) *



- J5 : 1 X 3 pin
- J6 : 1 X 4 pin

17. Pin-header (female)



- J7, J8 : 1 X 2 pin
- J3 : 2 X 20 pin

18. Slide switches



- SW1, SW 2, SW3 : 2P3T

19. BNC connector



- J1 : BNC

20. Test signaling ring



- 1) Make a small ring with a lead cut off.
- 2) Solder the ring to the two holes of J2 (as shown in the photo).

21. JP3

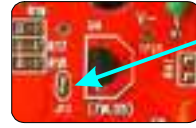

Short JP3 with solder

22. LCD Board



Note: Install to the side opposite to LCD panel.

- J1 : 2 X 20 pin
- J2, J3 : 1 X 2 pin



The assembly should look like this after you have finished all parts

Step 2 Test and Use

NOTE: You need a 9V DC power supply (at least 200mA capacity) to run the scope. This power supply is not included in the kit.

A. Check voltages

- 1 Apply 9V power to J10 (or J9).
- 2 Check voltage at TP22. It should be around +3.3V.
- 3 If voltage at TP22 is good disconnect power. Short JP4 with solder permanently.

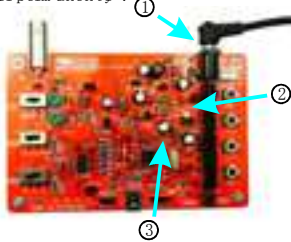

B. Attach LCD board

Plug LCD board into the female headers J3, J7, and J8 on the main board.



C. Verify

- 1 Connect power supply again. You should see LCD lights up and oscilloscope panel displayed.
- 2 Press various buttons and move switches to verify their functions.



Trigger! LED blinking twice indicates booting-up is good.

A. Use

- 1 Attach probe clips to J1.
- 2 Touch the red clip with your finger. Do you see signal from your finger?

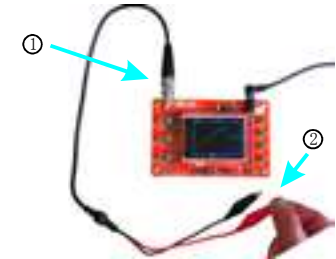

Troubleshooting

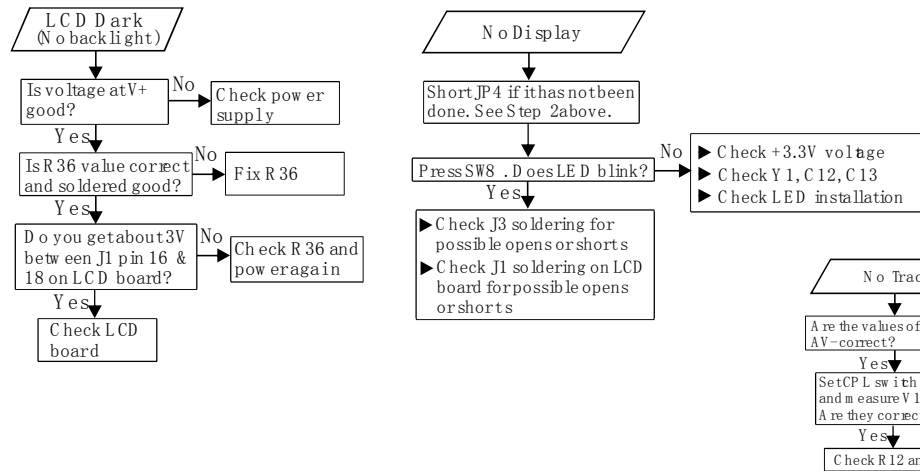

NOTE: The voltages in the photo are for reference only. The voltages on your board could be different. But they should be close to the values shown.

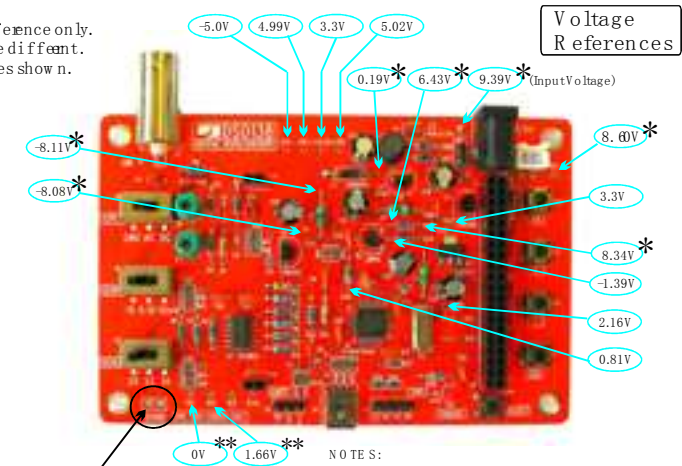

Place the negative pen of voltmeter here to do voltage measurements.

NOTES:
 *: These voltages are input voltage dependent. The values shown were measured when input voltage was 9.39V.
 **: These voltages are measured when CPL switch (SW1) is set to GND position.

How to Use

Display and Controls

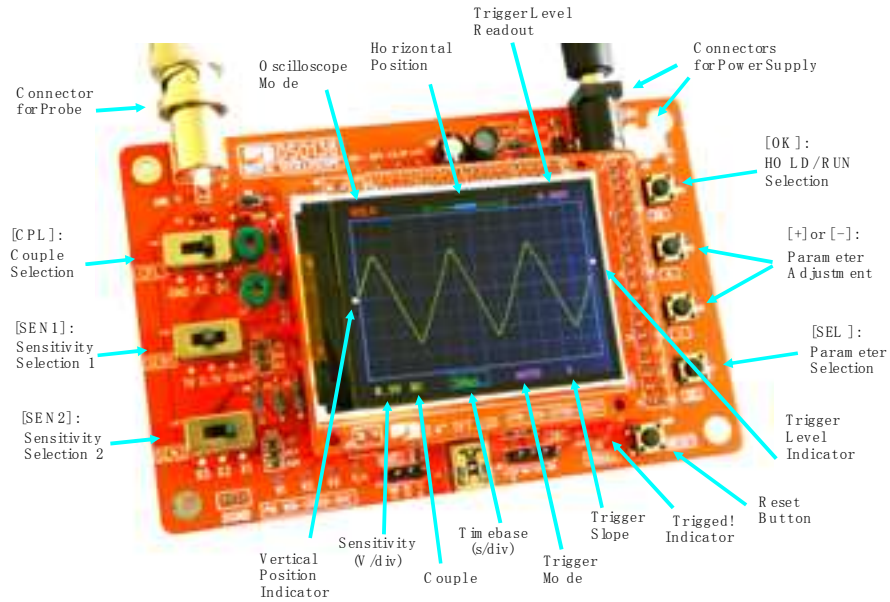

Connections

Power Supply: Connect DC power supply to J9 or J10. The power supply voltage must be in the range of 8-12V.

Probe: Connect probe to J1.

Attention

1. Power supply voltage must not exceed 12V. Otherwise U5 will get hot.
2. A allowed maximum signal input voltage is 50V pk (100V pp) with the clip probe.

Operations

Press on [SEL] button: Select parameter to be adjusted. The selected parameter will be highlighted.

Press on [+] or [-] button: Adjust the parameter selected by [SEL] button.

Press on [OK] button: Freeze waveform refresh (entering HOLD state). Press on it again will defreeze.

Change [CPL] switch: Set couple to DC, AC, or GND. When GND is selected the scope input is isolated from input signal and connected to ground (0V input).

Change [SEN 1] or [SEN 2] switch: Adjust sensitivity. The product of [SEN 1] and [SEN 2] settings makes the actual sensitivity which is displayed at the low-left corner of the panel.

Press on [Reset] button: Perform a system reset and re-boots the oscilloscope.

0V Line Alignment

Sometimes you may find the 0V line (the trace corresponding to 0V input voltage) does not match with the VPOS indicator at the screen left border. This can easily be fixed by performing the 0V line alignment function. First, set the couple switch [CPL] to GND position. Then press on [SEL] button to make VPOS indicator highlighted and hold down [OK] button for about 2 seconds. You will set the trace aligned to VPOS indicator when you release [OK] button. You may see some residue mismatch remains at the highest sensitivity settings. This is normal.

Probe Calibration

Because there is always some capacitance between scope input and ground probe needs to be calibrated to achieve better measurement results for high frequency signals. This can be done with the help of the built-in test signal. To do this please follow the steps below.

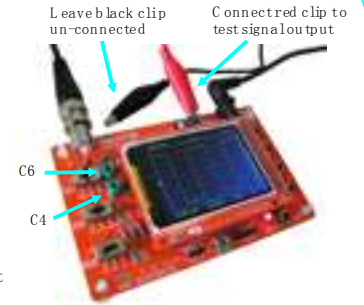

1. Connect the red clip to the test signal terminal and leave the black clip un-connected (see photo at right).
2. Set [SEN 1] switch to 0.1V and [SEN 2] switch to X5. Set [CPL] switch to AC or DC.
3. Adjust time base to 0.2ms. You should see a waveform similar to that shown in photos below. If traces are not stable adjust trigger level (the pink triangle on right screen border) so as you get a stable display.
4. Turn C4 (capacitor trimmer) with a small screw driver so that the waveform displays sharp right angle (photo C).
5. Set [SEN 1] switch to 1V and [SEN 2] switch to X1 while keep all other settings unchanged. Adjust C6 so that sharp right angle waveform is displayed.



A ~ Not enough

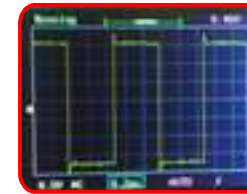

B ~ Too much



C ~ Good

Hints

The LED at bottom-right corner (labelled TRIGGERED!) is the trigger indicator. It blinks when triggers are detected.

Triggers and Their Modes

Triggers are events that indicate signal voltage crossing a set level (i.e. trigger level) along a specified direction (i.e. trigger slope, rising or falling). Oscilloscope uses triggers as reference points in time for stable waveform display and measurements.

Auto Mode

In auto mode oscilloscope will perform display refresh no matter triggers happen or not. When triggers are detected waveform display will be displayed with reference to trigger points. Otherwise, display waveform at random reference points.

Normal Mode

In normal mode oscilloscope will only perform display refresh when there are triggers. If no triggers happen waveform display will stay unchanged.

Single Mode

Single mode is the same as normal mode except that oscilloscope will enter HOLD state after trigger has been detected and waveform display has been updated.

Normal and single modes are useful for capturing sparse or single waveform.

Specifications	
Max real time sample rate	1M Sa/s
Analog bandwidth	0-200KHz
Sensitivity range	10mV/div - 5V/div
Max input voltage	50V pk (1X probe)
Input impedance	1M ohm / 20pF
Resolution	12 bits
Record length	1024 points
Timebase range	50ns/div - 10us/div
Trigger modes	Auto, Normal, and Single
Trigger position range	50%
Power supply	9V DC (8#12V)
Current consumption	~120mA
Dimension	117 x 76 x 15mm
Weight	70 gram (without probe)

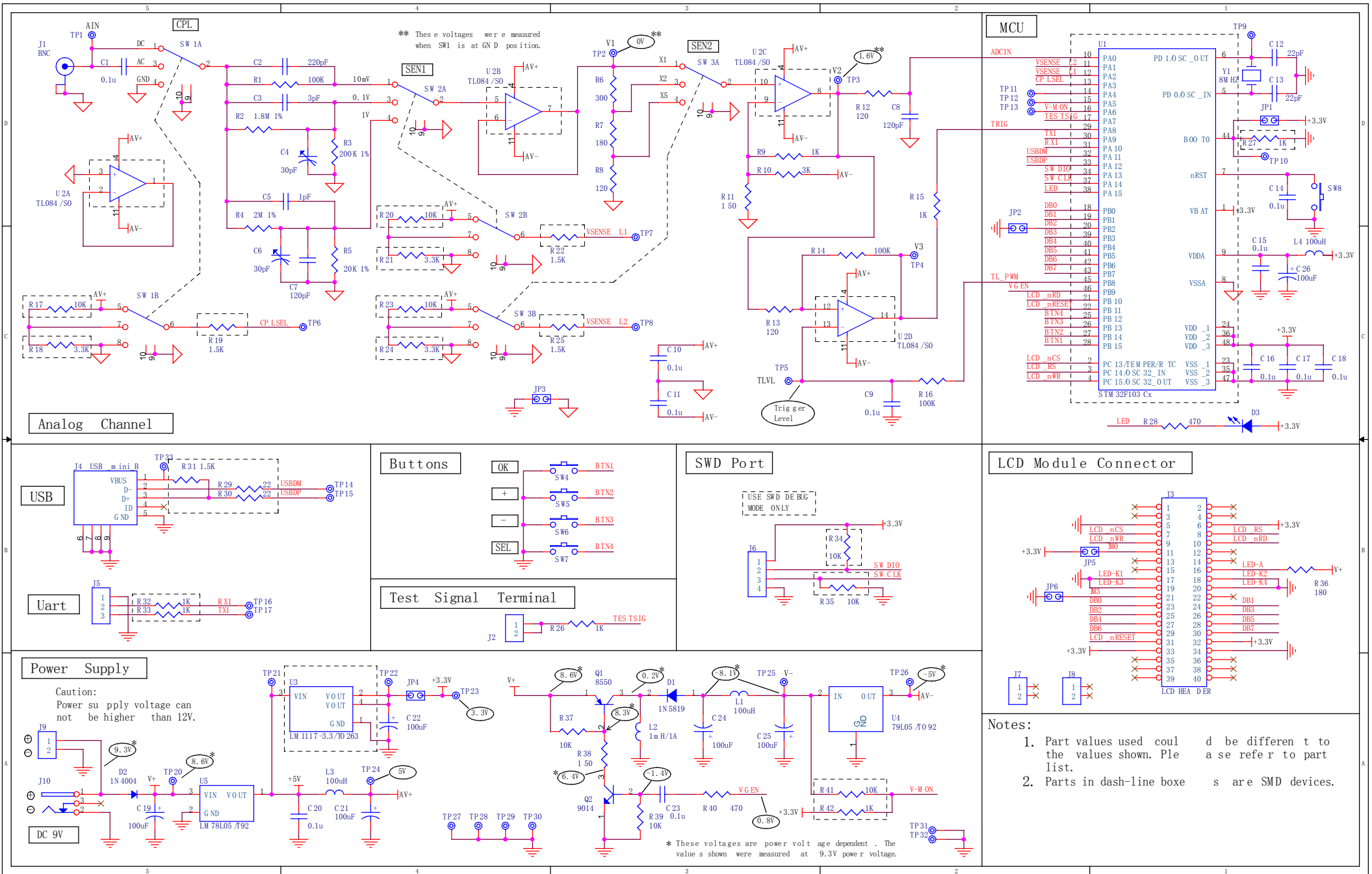

- Notes:
1. Part values used could be different to the values shown. Please refer to part list.
 2. Parts in dash-line boxes are SMD devices.